

'TECHNICAL SHORTS'

by Gerry O'Hara, G8GUH

'TECHNICAL SHORTS' is a series of (fairly) short articles prepared for the Eddystone User Group (EUG) website, each focussing on a technical issue of relevance in repairing, restoring or using Eddystone valve radios. However, much of the content is also applicable to non-Eddystone valve receivers. The articles are the author's personal opinion, based on his experience and are meant to be of interest or help to the novice or hobbyist – they are not meant to be a definitive or exhaustive treatise on the topic under discussion.... References are provided for those wishing to explore the subjects discussed in more depth. The author encourages feedback and discussion on any topic covered through the EUG forum.

The Eddystone Dial Drive Mechanism and Gearbox

Introduction

The dial drive mechanism fitted to Eddystone sliderule dial receivers has always been a subject of wonder and awe (when working well) and frustration and cursing (when it is not). Indeed, the Eddystone name is renowned worldwide for the smooth and quite distinctive feel of the flywheel drive fitted to all their post WWII valve sets. The basic drive mechanism concept essentially remained unchanged for some 25 years – the hallmark of a successful and good design – and, judging by the amount of service some of these receivers have had during their many decades of use - the tuning knob on my S.940 had been spun so many times that the bronze bush (bearing) had worn out! - is very, very reliable. However, over these decades, many sets have had their innards tampered with, either for genuine servicing, modifications or just curiosity – for example, even cleaning the dial glass and scale plate requires that the front panel be removed in pre-1962 sets. Removing the front panel inevitably disturbs the drive mechanism (though not by much if you are careful) and the temptation is there to 'tweak' this, lubricate that



etc. Other things also happen, such as the dial cord breaking, necessitating re-stringing the drive, or worse, this happening in 'full spin' of the dial and the metal cord becoming entwined between the plastic gears on the spool pulleys and the brass gearbox pulleys into which they mesh – this often leading to damaged teeth on the plastic pulleys (one can be tolerated, two or more missing or badly damaged prevents the mechanism from working correctly).

I have written about various aspects of the dial drive in my restoration articles, including step by step description of removal/replacement of the front panel in the sets described, but continued interest in the mechanism and how it should be adjusted for optimum performance led me to prepare this article that takes the dial drive maintenance process a step further by disassembling/re-assembling the gearbox, as well as providing some drawings and further details on various aspects of the drive mechanism operation.

Description of the Drive Mechanism and its Operation

The 'standard' Eddystone dial drive mechanism is not complex. It comprises three main components:

- The tuning shaft/flywheel/pinch-wheel (friction) drive (photo, right);
- The reduction gearing (gearbox) - photo, below left. In most sets this includes a drive to the vernier scale (though not in sets where an 'incremental' tuning is provided on the first IF, eg. in the 830 series); and
- The dial cord arrangement (photo, below right). This differs somewhat from set to set.



The following sections describe these main components in some detail, followed by a disassembly/re-assembly procedure that should help anyone that has never undertaken this task before and who needs to as a result of a failure or malfunction of the mechanism – this often results from gummed-up gears or bearings or even the dial cord jamming between the gears, as noted above.

Important: before you start, make a sketch of the dial cord arrangement and take several photos of the entire drive system that will allow reference to how things looked before disassembly – these extra few minutes will be well spent and can often save much cursing and frustration later. Oh, and make a fresh pot of your favourite tea, your probably going to need the mental stimulation it provides...

The Pinch-Wheel Drive

Photo, right: this (and the dial stringing - see later) is probably the most

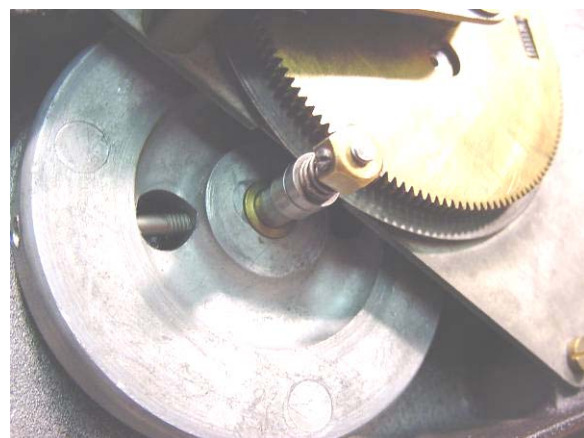

'problematic' set of components of the entire arrangement – not because it is poorly designed or manufactured, but because it is usually disturbed when the set is partly dismantled as noted above. Removal of the front panel results in the pinch wheel (a spring-loaded clutch) becoming disengaged from the 'big wheel' or 'friction plate'. It therefore becomes the focus of a lot of well-meaning fiddling, poor adjustment, unwise lubrication and even damage that often results in a less-than-perfect result...

The diagram below shows the arrangement, which is also illustrated on the photos on this and the next page. It can be seen from these illustrations that the components are a:

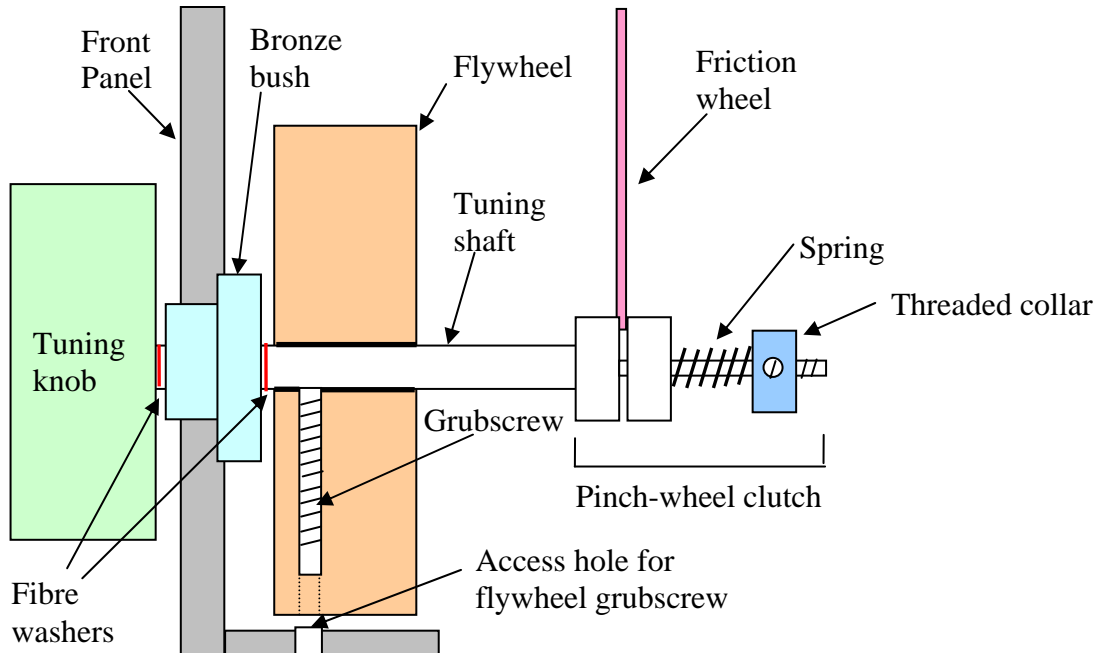

- 0.25" OD steel tuning shaft with the outer (front) part of the pinch wheel machined as one unit (photo, below). The inner (rear) end of the tuning shaft is partly threaded, and onto which is mounted;
- The inner part of the pinch wheel, a compression spring and a threaded brass collar fitted with a locking grub screw (photo, left);



- The flywheel, located forwards

- of the pinch wheel, held in place by one (sometimes two) long 4BA grub screws;
- A bronze/brass bush (bearing) through which the tuning shaft passes (photo, below left). This bush is fitted with a flange that has three holes drilled through it.



The centre of the bush passes through the front panel casting (flange to the outside) and is fixed to the front panel by three 6BA screws that pass through it and that screw into a round plate located on the inner side of the front panel casting and that passes over the bush. The

bush has a small lubrication hole located on its upper front side (note: the bush can wear out - and did on my S.940 - to the point where the tuning shaft can rattle in the bush, completely spoiling that slick 'Eddystone feel', even if the rest of the drive train is perfectly adjusted. Replacement bushes can be obtained from Ian Nutt;

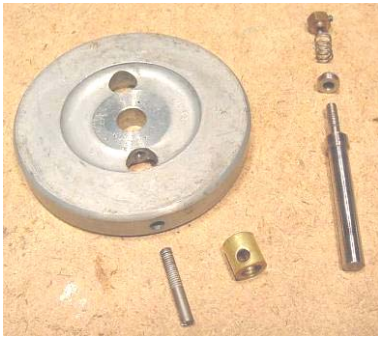

Note that this flywheel has a brass insert in its centre (removed in the photo)

- Two or three small fibre washers, located either side of the bush; and
- The tuning knob, affixed by two grub screws to the outer end of the tuning shaft.

The threaded collar is adjusted along the threaded portion of the tuning shaft such as to ensure that the pinch wheel affords adequate lateral pressure onto the friction wheel attached to the gearbox. I have not found this adjustment to be too critical and half-way along the threaded section should be fine.

The tuning shaft is held in place by both the flywheel and the tuning knob. There are two critical adjustments here:

1. The location of the tuning shaft bush (bearing) on the front panel casting (circled red on the photo, right): the three holes in the front panel allow quite a bit of movement – this affects the amount of engagement of the friction wheel into the pinch wheel. Insufficient engagement will cause the mechanism to slip (tuning knob spins round and the dial does not move/moves intermittently), whereas too much engagement can result in binding and a drive that feels 'sticky'.
2. The position of the flywheel on the tuning shaft: this controls the mating angle of the friction wheel and the pinch wheel. If the flywheel is located too far forwards on the tuning shaft and the tuning knob located to avoid excessive end-play of the shaft, then the friction wheel will be pushed rearwards and will therefore be bending backwards, causing strain on the mechanism and a 'binding' feeling when the tuning knob is spun. Similarly, if the flywheel is located too far back on the tuning shaft and the tuning knob located to avoid excessive end-play, then the friction wheel will

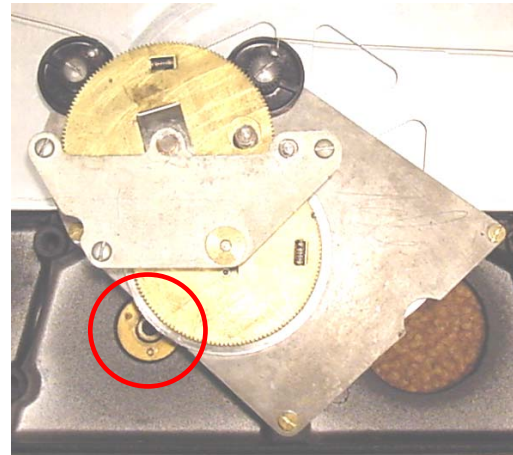

be pushed forwards and will therefore be bending forwards, again causing strain on the mechanism and that undesirable 'binding' feeling when the tuning knob is spun. The correct location of the flywheel can be made by:

- Engaging the friction wheel into the pinch wheel as noted above and ensuring this part of the mechanism is working ok;
- Check that a fibre washer is located between the front of the flywheel and the bronze bush;
- Loosen the flywheel grub screw(s) - through the hole for this purpose located on the bottom edge of the front panel casting;
- Position the tuning shaft (by adjusting the position of the brass bush on the front panel) such that the friction wheel and the pinch wheel are engaged and so that the friction wheel is not warped either backwards or forwards;
- Holding the tuning shaft in this position, and with the flywheel pressed against the rear of the bronze bush (fibre washer in-between), tighten the flywheel grubscrew(s);
- Still holding the flywheel against the rear of the bronze bush, place a fibre washer onto the front (outside) of the tuning shaft and then place the tuning knob on the drive shaft;
- Tighten the tuning knob grubscrews when the tuning knob is located such as to provide just enough end-play that the tuning shaft spins freely and without any rattling noises – this may take a few attempts to obtain the optimum 'feel'.

Note: if you are re-assembling from scratch, ensure that the bush is pre-lubricated using moly grease and that a little moly grease is smeared onto the rear and front of the bush where it contacts the flywheel and the tuning knob. Alternately, use a light machine oil, however, **do not** use 3-in-One oil as this becomes a sticky gum after a prolonged period that can jam the mechanism. Make sure that the contact surfaces of both the pinch wheel and friction plate are free of any oil or grease. Also, ensure that the small fibre washers are fitted on the tuning shaft between the flywheel and the rear of the brass bush and between the tuning knob and the front of the bush (see diagram on page 3).

The Gearbox

The typical post-WWII Eddystone gearbox seems to be fairly problem free, being a simple, straightforward design incorporating rather stout brass gears, these being split and spring loaded to prevent backlash. The gearbox design varies in detail from model to model but all are very similar. I have used an S.750 gearbox for illustration here (thanks to Pat from SPARC for the loan!) and some of the description presented is specific to that model. However the basic description and principles of operation, dismantling and reassembly apply reasonably well to other models of the same era.

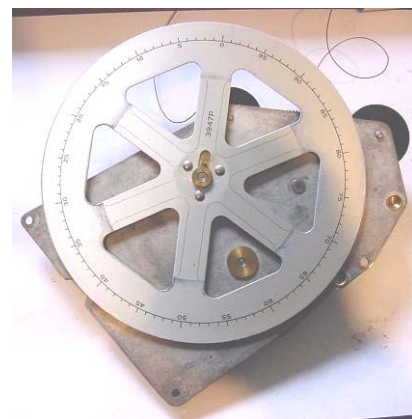

Gearbox Construction

A diagram of a typical Eddystone gearbox is shown at the top of the next page (a Model S.750) and a photo of the same unit is shown at the bottom of this page (the red arrows on the diagram depict the direction of movement of each moving part for a clockwise spin of the tuning knob). The drive train in this version of the gearbox comprises:

- a 3.125" OD, spring-steel friction wheel, driven by the pinch-wheel described above, riveted (3 rivets) to the primary of a;
- 2.8125" OD, 135 tooth brass dual (split) gearwheel mounted on a 0.125" steel shaft onto which is also mounted a;
- 0.3125" OD, 15 tooth brass pinion, engaging both the primary and secondary gears of a;
- 3.125" OD, 150 tooth brass spring-loaded dual (split) gearwheel, the primary of which also engages;
- two 0.625" OD plastic (eg. Delryn) 24 tooth spool pulley pinions (eg. p/n 3954P). The spool pulleys are 1.25" OD and have four grooves in their outer surfaces to accommodate the dial cord.
- A 0.5625 OD, 27 tooth brass pinion engages the primary of the 135 tooth dual gear wheel, the 0.125" steel shaft of which protrudes from the front of the gearbox and onto which is attached the circular vernier scale (calibrated 0 to 100). The vernier scale is attached to the 27 tooth pinion shaft by a grub screw in its boss.
- The bronze-plated steel dial cord is soldered to metal pins embedded into the

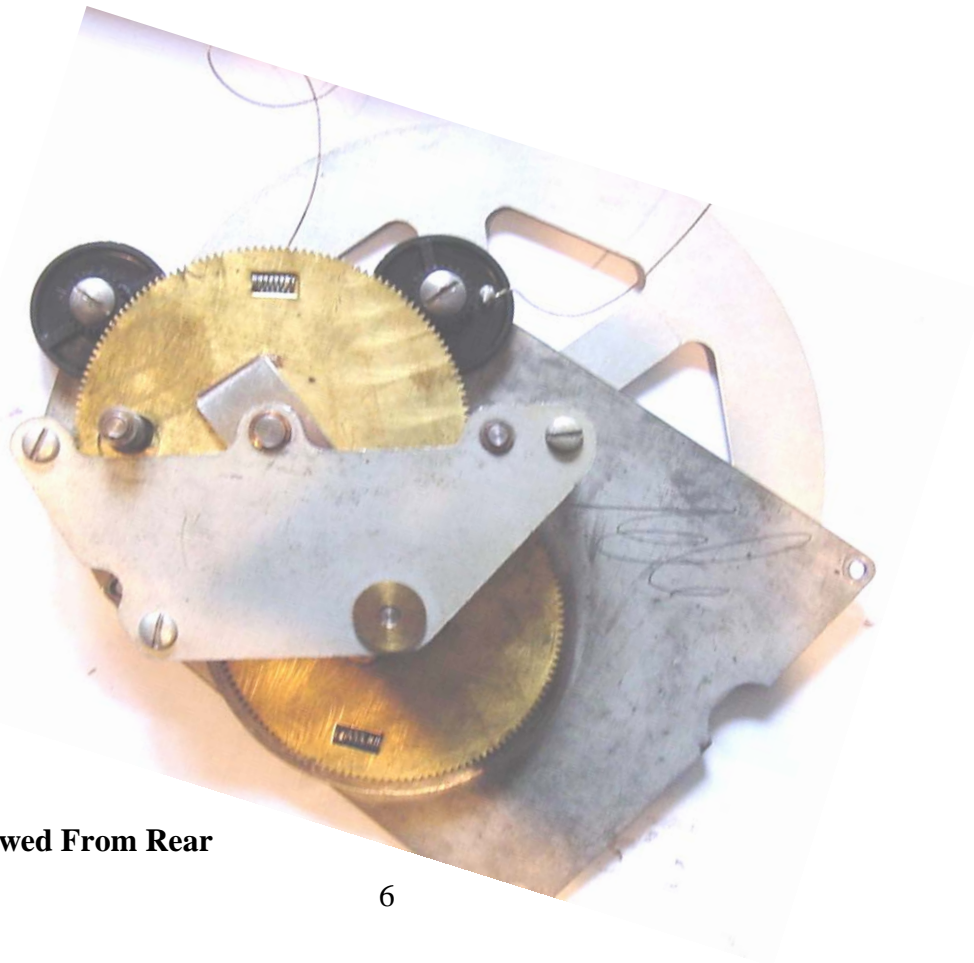

Viewed From Rear

spool pulleys and is soldered at its mid point to the brass slider of the dial pointer (actually, the dial cord in the set featured in my S.750 restoration article is a fabric cord knotted into the spool pulleys and attached to the dial pointer slider with a screw: an example of either a replacement at some stage in the set's life or of a variation in design over the production life of the model).

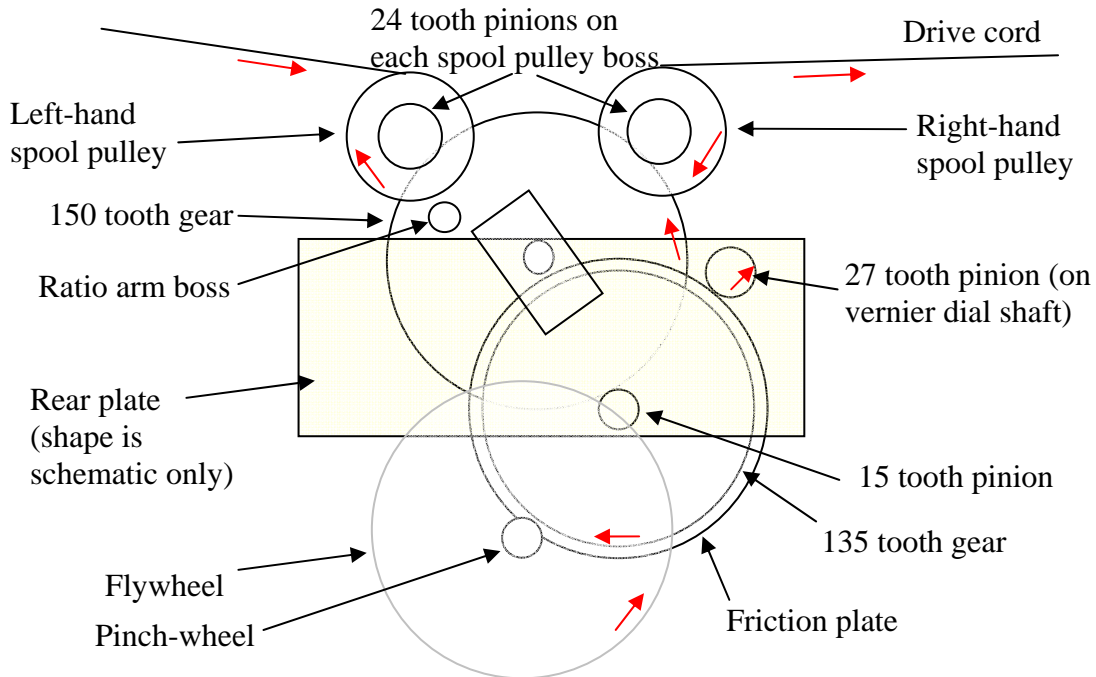

Viewed From Rear

Gearbox Operation

The side plates of the gearbox are 14 gauge steel: the front plate is the larger of the two and is mounted onto the front panel aluminium casting using three 4BA screws. The rear plate is attached to the front plate by three 0.6875" brass spacers and 4BA screws. The 0.125" steel shaft of the 135 tooth gearwheel/15 tooth pinion is set into brass bushes fitted into the front and rear plates, a brass washer (spacer) is placed between the 15 tooth pinion and the rear brass bush. The 0.25" steel shaft of the 150 tooth gear wheel is set directly into 0.25" holes in the front and rear plates, with a spring steel spacing plate located between this gearwheel and the rear plate, this shaft being held in place with a circlip located behind the rear plate. The 0.125" steel shaft of the 27 tooth pinion is also set directly into 0.125" holes in the front and rear plates and held in place with a circlip. The spool pulleys are mounted on steel shoulder bolts screwed into the top of the front plate, their 24 tooth pinions engaging the top of the 150 tooth gearwheel.

In the case of this particular S.750 drive, the pinch wheel to friction plate provides a nominal 19:1 reduction ratio (the exact ratio depends on the degree of engagement). The 15 tooth pinion to 150 tooth gear then provides a further 10:1 reduction ratio, resulting in a total of ~190:1 reduction between the tuning shaft and the 150 tooth gear, this being coupled to the tuning gang capacitor - via the ratio arm in the S.750. The 150 tooth gear to 24 tooth gear on the spool pulleys provides a 1:6.25 ratio, representing a total reduction

ratio of $\sim 30.4:1$ between the tuning shaft and the spool pulley. The OD of the spool pulley is 1.25" (actually a little less for the grooves that accommodate the dial cord, say 1.22"), representing 3.83" circumference. The (logging) scale is 12" long, therefore the pulleys must turn approximately 3.13 times for one traverse of the scale length, representing some 95 turns of the tuning shaft for one complete traverse of the main logging scale. The main logging scale is divided into 5 primary segments (marked at 500, 1000, 1500 ... 2500), each 2.4" long, each primary segment thus representing 0.625 turns of the spool pulleys, and therefore 0.1 turns of the 150 tooth gear, 1 turn of the 135

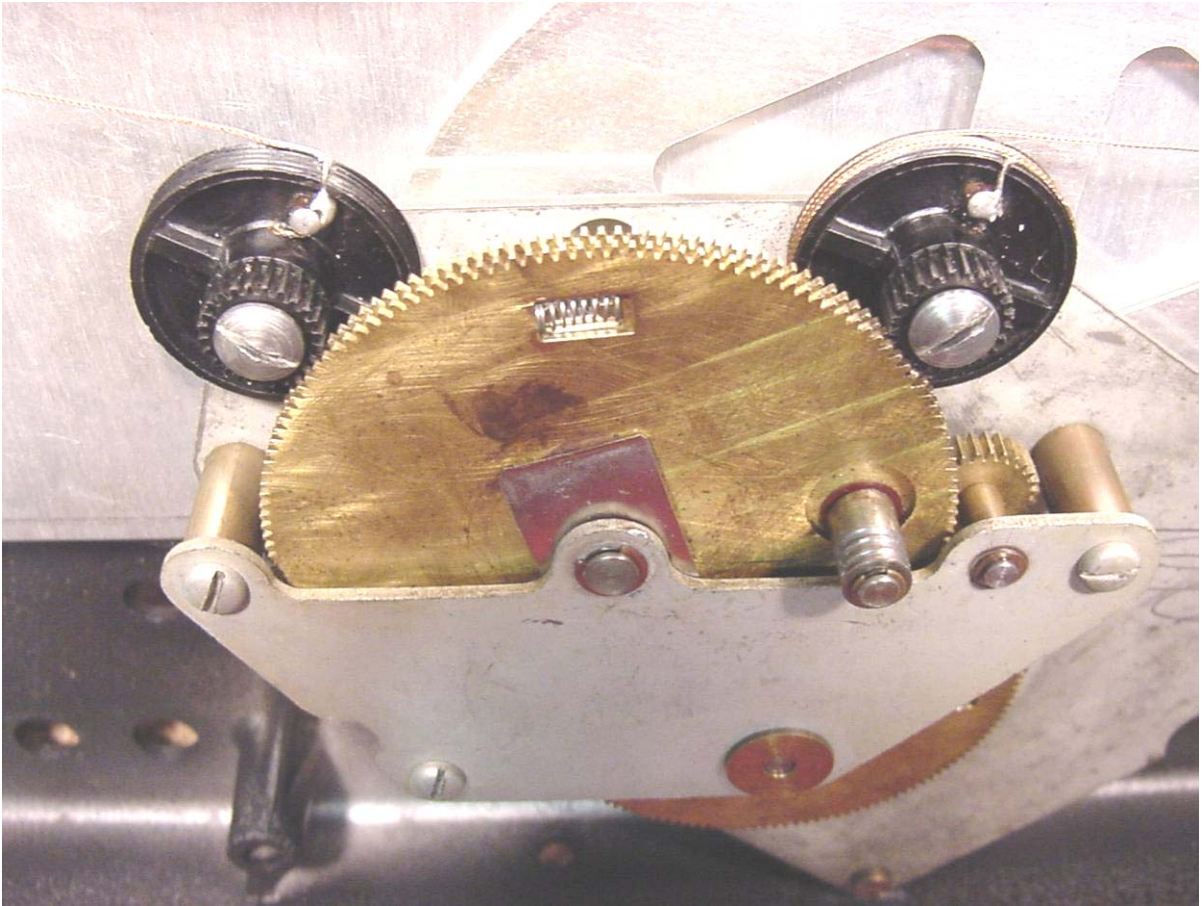

Above: view of S.750 gearbox from rear. The large brass dual gearwheel at the top is the 150 tooth gear. This meshes with a 15 tooth pinion fixed to the same shaft as the 135 tooth gear (just visible, lower right). The 27 tooth pinion fixed to the vernier drive shaft can be seen located to the right of the 150 tooth gear. This pinion meshes with the 135 tooth gearwheel.

tooth gear and 5 turns of the 27 tooth gear attached to the vernier scale. Thus the vernier scale will rotate 25 times during one traverse of the main logging scale (5 times per primary segment). As the vernier scale is calibrated into 100 divisions, this gives the 2500 logging markers as represented on the logging scale (I told you it was simple...). As the diameter of the markings on the vernier scale is around 5", representing a lineal length of 15.7", 25 turns is equivalent to a vernier scale length of approximately 32'. The total vernier scale length for the complete tuning range (four bands) is therefore 128'.

Note: the details of the actual gearing arrangement and ratios vary between models (eg. the S.940 logging scale is 12.625" long and ends at 2300, my particular S.940 requiring 58.5 rotations of the tuning knob to go from zero to 2300, whereas the S770/R has a 12" logging scale, ending at 2500 – as in the S.750 – but on my set it takes 128 rotations of the tuning knob to cover it). The physical arrangements, sizes and shapes of other parts also differ somewhat between models, however the same general description applies.

Gearbox Disassembly/Reassembly

To remove the gearbox, the set must be disassembled to the point that the front panel has been completely separated from the remainder of the set (this operation is described in several of my restoration articles).

Once the set is at this stage:

- Remove the three 4BA screws that fix the front gearbox plate to the front panel casting and lift the gearbox away from the front panel (the pinch-wheel on the tuning shaft will disengage from the friction wheel on doing this);
- With the front panel facing downwards, lift the gearbox over the top of the front panel and place on the workbench above the front panel. This allows the scale plate to be removed – at least in the S.750 (4 x 4BA screws, one acting as the pivot for the dial cord tensioner pulley arm):
- Carefully lift the scale plate away from the front panel and store in a safe place (take this opportunity to clean it using a soft cloth/cotton wool ball and soapy water);
- Remove the two idler pulleys from either end of the tuning scale (2 x 4BA screws attach these to the pointer guide rod mounts in the S.750). The entire guide rod assembly can be cleaned while it is removed, as can the dial glass;
- Remove the two spool pulleys and the attached dial cord from the gearbox front plate by loosening the two shoulder bolts;
- Remove the vernier scale from the 27 tooth pinion shaft by loosening the grub screw in its central boss (clean the vernier scale using soapy water and store in a safe place);
- Remove the three 4BA screws that attach the rear gearbox plate (the smaller plate) to the brass pillars attached to the front plate. The gearbox may now be carefully pulled apart;

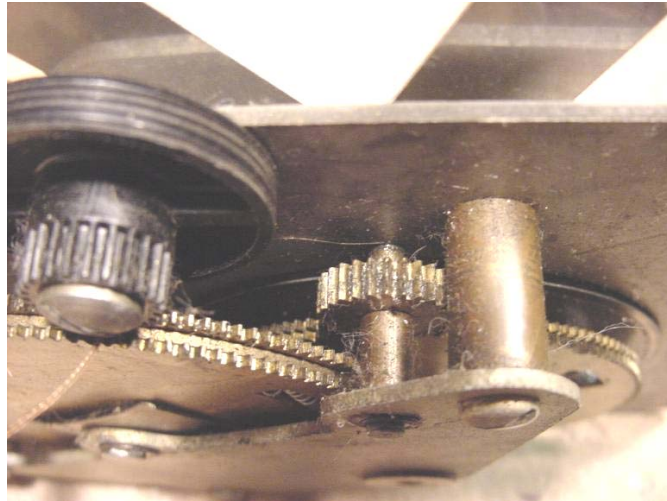

Above: view of S.750 gearbox before dismantling and cleaning. The (black) spool pulley 24 toothed boss can be seen meshing with the 150 tooth gearwheel, and the 27 tooth pinion on the vernier drive shaft meshing with the 135 tooth gearwheel, below.

- The 135 tooth gear/15 tooth pinion/friction plate assembly can now be removed and set aside (note that there is a brass spacing washer on the pinion end of the shaft);
- Remove the small circlip from the rear end of the 27 tooth pinion shaft and the pinion/shaft assembly can be removed;
- Remove the circlip from the rear end of the 150 tooth gear shaft and the 150 tooth gear assembly can now be removed;
- Test the spring-loaded 135 and 150 tooth dual gear assemblies for operation: each assembly should allow the primary and secondary gears to be freely rotated slightly (the extent of the spring travel). If this is sticky, carefully remove the springs from the affected assembly. In the example used here, the 150 tooth gears can be completely separated and cleaned, however, the 135 tooth gears can only be separated slightly – this allows solvent or penetrating oil to be poured between them to dissolve any ancient gummed-up lubricant. Once the gears can be rotated freely, replace the springs and re-check operation of the spring-loaded mechanism (if this mechanism does not work smoothly, this can cause unwanted backlash or stickiness in the drive train);
- Clean all old lubricant and gum from bearings, shafts, gears and the friction plate, as well as the gearbox side plates. Also, clean the two spool pulleys and their shoulder bolts.

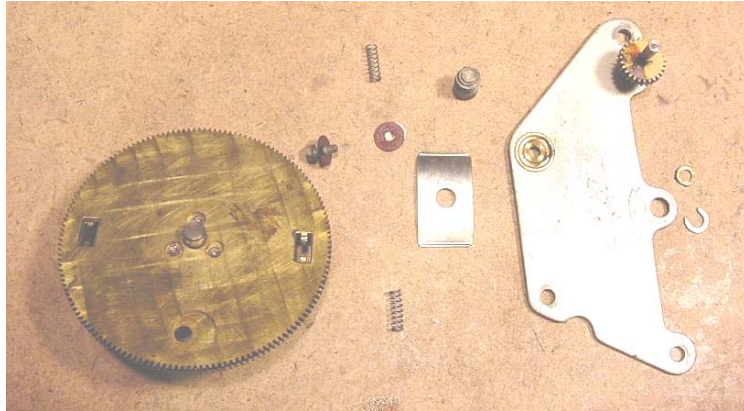

Now that everything is dismantled and clean, check for damaged teeth, worn bearings etc. (note, the gearbox will still tend to work with one or two damaged or missing teeth from a gear). Replacement parts may be obtained from a 'spares set', enquiring to Ian Nutt or appealing on the EUG website. Sometimes small copper washers (shims) will be present on the gear spigots/shafts to set the end float of the gears. Be careful not to lose any such shims, other small washers/spacers/ circlips etc. that are present (store them in a container) and make a note/sketch where they all go - though be aware that someone may have been there before you and perhaps they 'got it wrong' when re-assembling... A photograph showing all the component parts of this particular S.750 gearbox is presented at the end of this article.

Reassembly is, as they say, 'simply a reversal of the above' – maybe it is (almost, but more fiddly), but I'll describe it step-by-step anyway...

- Temporarily secure the primary and secondary of each of the 135 and 150 tooth split gears together with two small pieces of masking tape, tensioning the springs slightly beforehand (by rotating the primary gear relative to the secondary by one

or two teeth) to ensure that any clearance between the teeth is taken up by the spring tension once assembled. In the case of the 150 tooth gear assembly, the masking tape also serves to hold the primary and secondary gears together (otherwise they are held together only with the two small tensioning springs and are apt to spring apart during assembly);

- Lubricate the inside of the two brass bushes in the gearbox plates using moly grease;

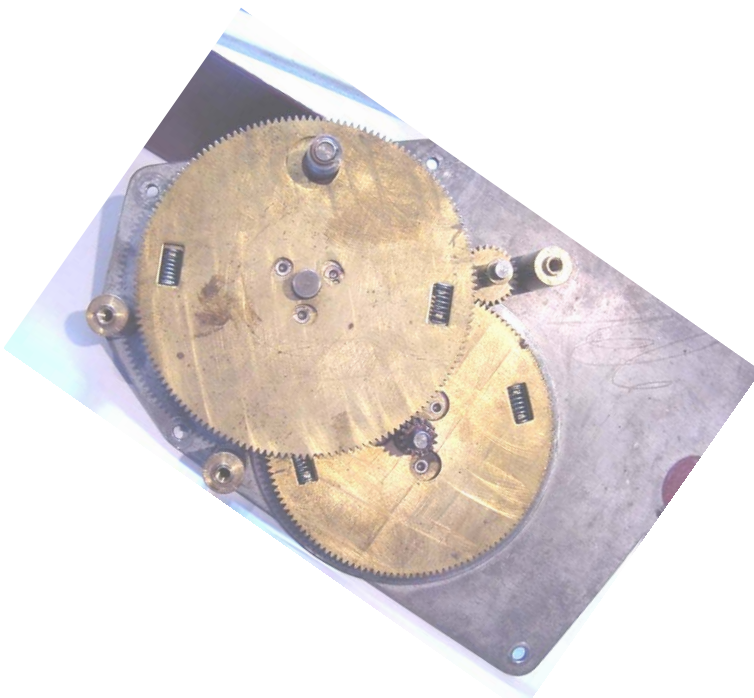

Above: view of S.750 gearbox during re-assembly, showing meshing arrangement of the brass gears without the rear plate in place.

inserted) on the workbench, carefully present the rear plate (with 27 tooth pinion installed) to mate with the rear end of the 150 tooth and 135 tooth gear shafts and the shoulders of the three brass spacers. This needs a good swig of tea and quite a bit of patience – gently move the various shafts until it clicks into place;

- Insert the 135 tooth gear shaft into the front plate bush;
- Lubricate the 150 tooth gear shaft with moly grease and insert the shaft into the front plate;
- Lubricate the 27 tooth pinion shaft and insert into the rear plate, attach with the small circlip;
- Place the spring-steel spacing plate onto rear of the 150 tooth gear shaft - use a little moly grease to hold it in place;
- Laying the front gearbox plate (with the 150 tooth and 135 tooth gear shafts

- Insert the three 4BA screws and, after checking nothing is binding, tighten to re-attach the rear plate. Note: the position of rotation of the gears is not important at this stage;
- Remove the pieces of masking tape from the 135 and 150 tooth gears: the springs will now try to rotate the split gears relative to each other and any clearance (slack) will be taken up;
- Put a spot of high quality light machine oil on any bearing surface not lubricated with moly grease, wipe off any excess;
- Re-attach the vernier scale to the front shaft of the 27 tooth pinion (do not over-tighten the grub screw);
- Lightly smear the spool pulley shoulder bolts with moly grease and (temporarily) install them onto the front plate of the gearbox to mesh with the 150 tooth gear;
- Rotate the friction plate with your fingers and check for smooth operation of the gear train;
- Once satisfied with the smoothness and general operation of the gearbox, it can be re-attached to the front panel using the three 4BA screws (first re-install the dial pointer guide rails, idler pulleys and scale plate);
- Lightly lubricate the teeth on the gearwheels and pinions with moly grease.

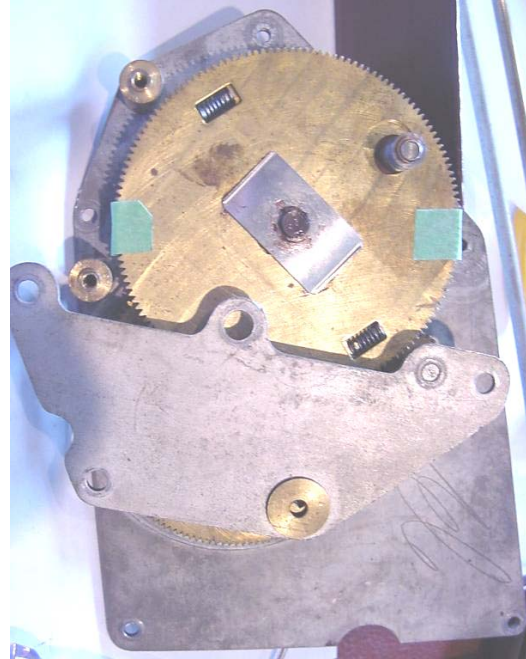

The Dial Cord Arrangement

This varies a fair bit from model to model (and for that matter, even within a model type: the S.750 setup described here differs from the one in my S.750 restoration article in that the spring-loaded tensioner pulley rides on the inside of the cord here and on the outside of the cord in the set in the restoration article). However, whilst I describe the particular arrangement for this particular S.750 herein, the general principal can be applied to all of the sliderule dial sets.

Attached to this article are some sketches and photos of dial cord arrangements for several Eddystone sets. The sketch below illustrates the arrangement in the S.750 front panel being serviced in this article (photo, right).

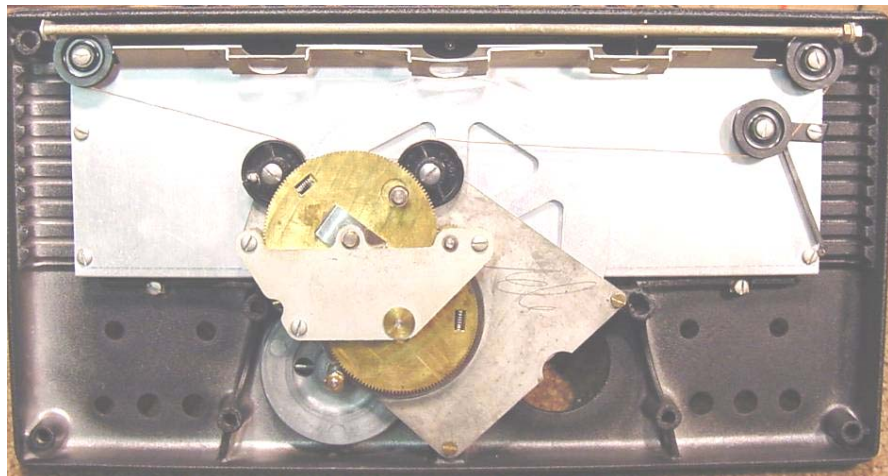

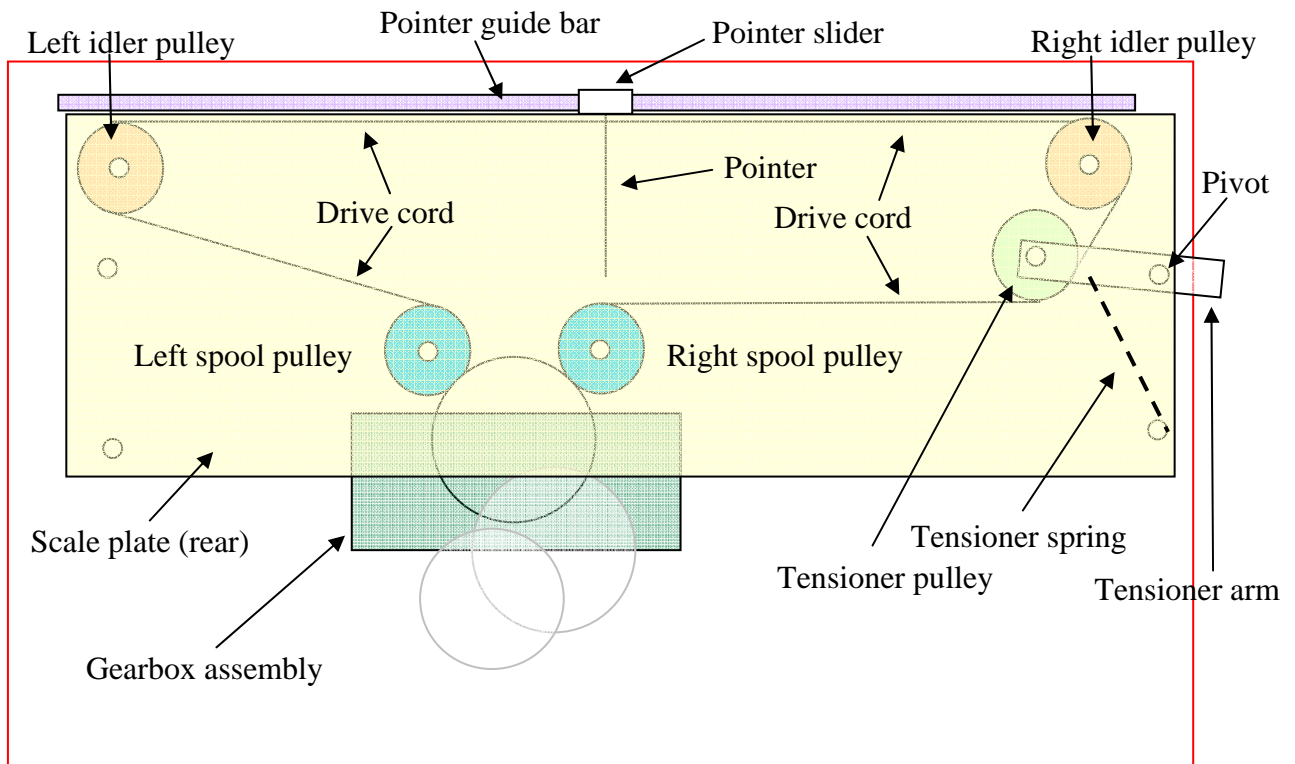

Re-Stringing the Dial

There are two basic ways of stringing the drive cord:

1. The 'pre-wound spool' method:

- Remove the spool pulleys complete with drive cord from the gearbox assembly;
- Place the dial pointer at 2500 on the logging scale;
- Rotate the 150 tooth gear wheel fully anticlockwise (in the case of the S.750) so that the ratio arm drive boss rests against the rear gearbox plate;
- Thread the dial cord around the left-hand idler pulley (looking from the rear of the front panel – see sketch, above);
- Wind the dial cord anticlockwise around the left-hand spool pulley (photo, below right), starting in the front groove and working towards the rear groove with each turn.

Temporarily secure in place using a small piece of masking tape;

- Secure the left-hand spool pulley in place on the

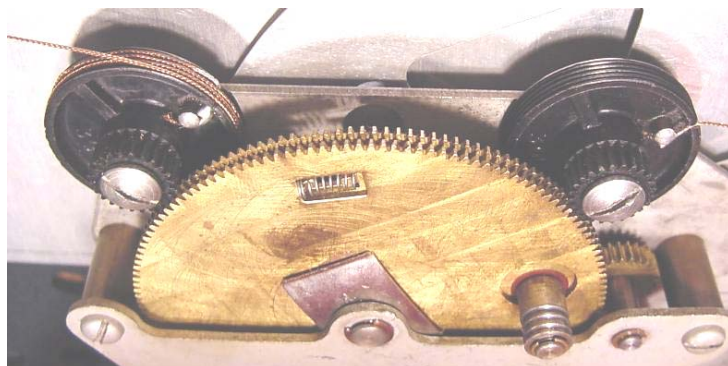

- gearbox front plate using its shoulder bolt;
- Thread the remainder of the dial cord around the right-hand idler pulley, around the tensioner pulley and then hold the right-hand spool pulley (attached to the dial cord) in its location on the gearbox. Rotate its gear teeth to mesh with the 150 tooth gear such that the tensioner arm is about half-way across its radius of movement and secure the right-hand spool pulley into position using the shoulder bolt;
- **Carefully** check operation of the dial by slowly running from one end of the scale to the other by turning the tuning shaft (if fitted to the front panel at this stage) or using your fingers on the 135 tooth gear/friction plate assembly – minor adjustment of the spool pulley gear mesh with the 150 tooth gear may be needed if the cord is too slack or too taut. Do not force anything as damage may result.

2. The 'spool as you go' method:

This method is described in the extract from Lighthouse (for an S.840A) at the end of this article (Issue 25, page 17). This method essentially lets the mechanism wind the dial cord onto the left-hand spool pulley during a full pass of the dial scale.

Check that the vernier scale zero mark coincides with the dial pointer being over a division marking on the main logging scale (photo below). If it is not, some sets allow adjustment by moving the pointer location on the dial cord (in this S.750, this means unsoldering/re-soldering the pointer slider onto the dial cord). Alternatively, if you did not over-tighten the vernier scale grub screw, hold the 135 tooth gear firmly (so the dial cord cannot move) and rotate the vernier scale to obtain the desired positioning (you didn't over-tighten that vernier scale grub screw did you?.....).

If the dial cord is broken or very worn, various readily-available materials have been suggested, including monofilament fishing line, pull-cord from Venetian blinds, a 'top-E' string from an electric guitar, standard non-



stretch woven nylon fabric dial cord (eg. as sold by Antique Electronic Supply, www.tubesandmore.com), or as suggested by Dave (M0TDH), Drennan bronze-coated stainless steel 7 Strand Pike Wire 24lb – 10.9kg, available from fishing tackle shops (noted as being the same as the original Eddystone fitment).

Conclusion

Well that's about it for the 'classic' Eddystone sliderule dial drive mechanism – fiendishly simple (ok, I admit that I was a Meccano nut in my pre-radio youth), reliable and robust, but in need of some TLC from time to time, mainly comprising sparse lubrication and cleaning of the friction plate/pinch-wheel. If your set's dial drive seems to be working ok, then my recommendation is do not attempt to take it apart and re-build it (the 'if it ain't broke, don't fix it' maxim applies big time here), however, if it exhibits symptoms of roughness, stickiness or the pointer does not cover the full extent of the scale markings (or at least the logging scale), then an inspection is warranted. The information provided in this article, attachments and references should provide a good basis for understanding what you are doing...and I wish you the very best of Good Luck!

© Gerry O'Hara, G8GUH, Vancouver, BC, Canada, May, 2007



Some Useful References

Various sections of Eddystone manuals downloaded from the EUG web site and specific articles in Lighthouse including:

Subject	Issue	Page
dial, slippage	24.....	1
mechanism, description & maintenance.....	43.....	9
.....	46.....	4
drive cord comments	95.....	19
tuning, vernier scraping dial.....	89.....	29
drive cord	6.....	9
.....	61.....	28
drive cord, replacement & plan.....	37.....	3
.....	48.....	5
drive cord, restringing	25.....	17
drive cord	11.....	5
tuning gear problems.....	89.....	27
tuning cord reversed.....	79.....	12
tuning, backlash	8.....	17
tuning scale, backlash	33.....	20
tuning system, cleaning	56.....	2
tuning ratio	12.....	1
tuning mechanism problems.....	91.....	5
tuning cog repair	63.....	15
.....	95.....	9
tuning mechanism	26.....	2
ratio arm, setting	56.....	17
tuning system, cleaning	56.....	2

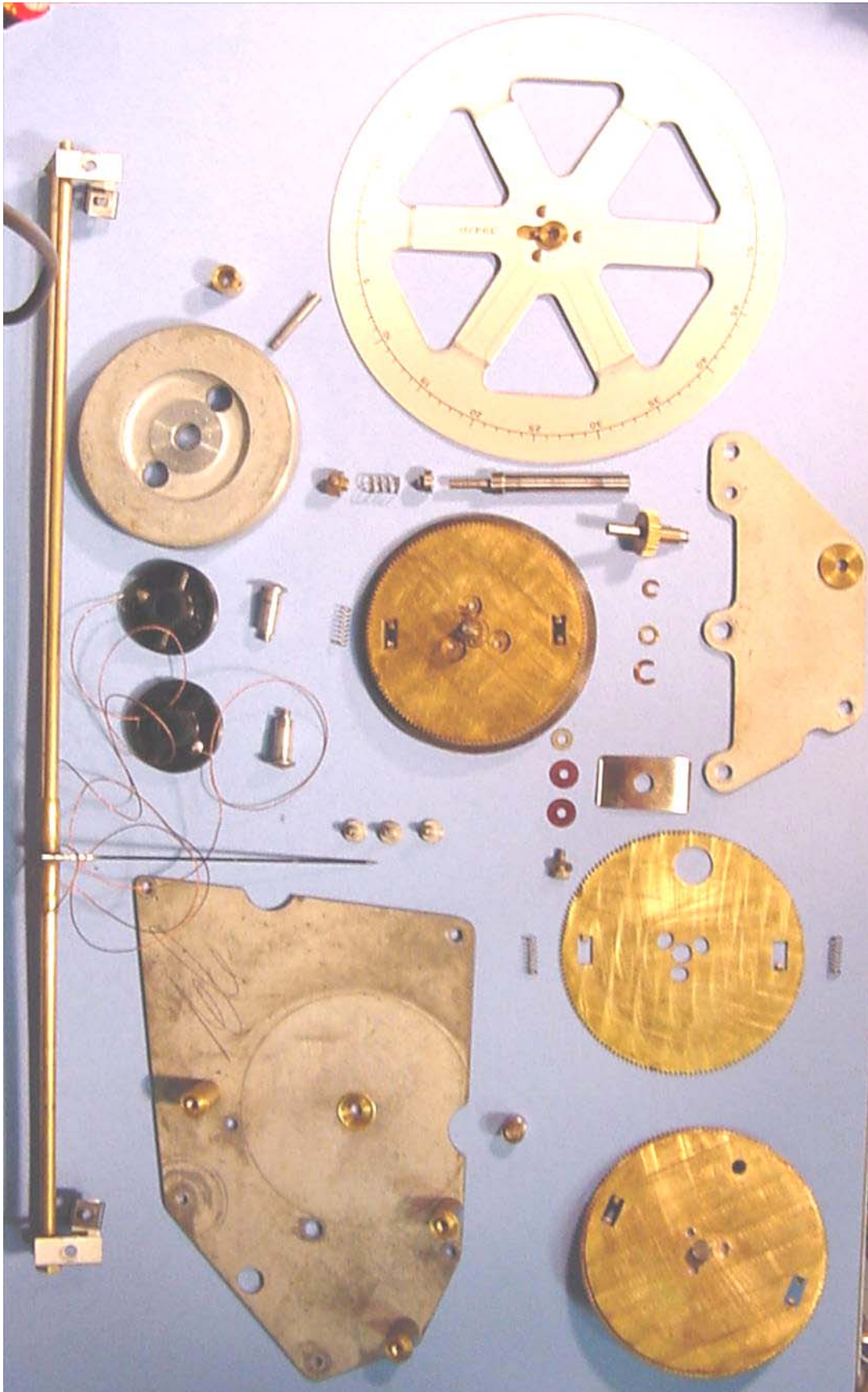

Complete set of drive mechanism components... almost (a gear tensioner spring has gone AWOL).



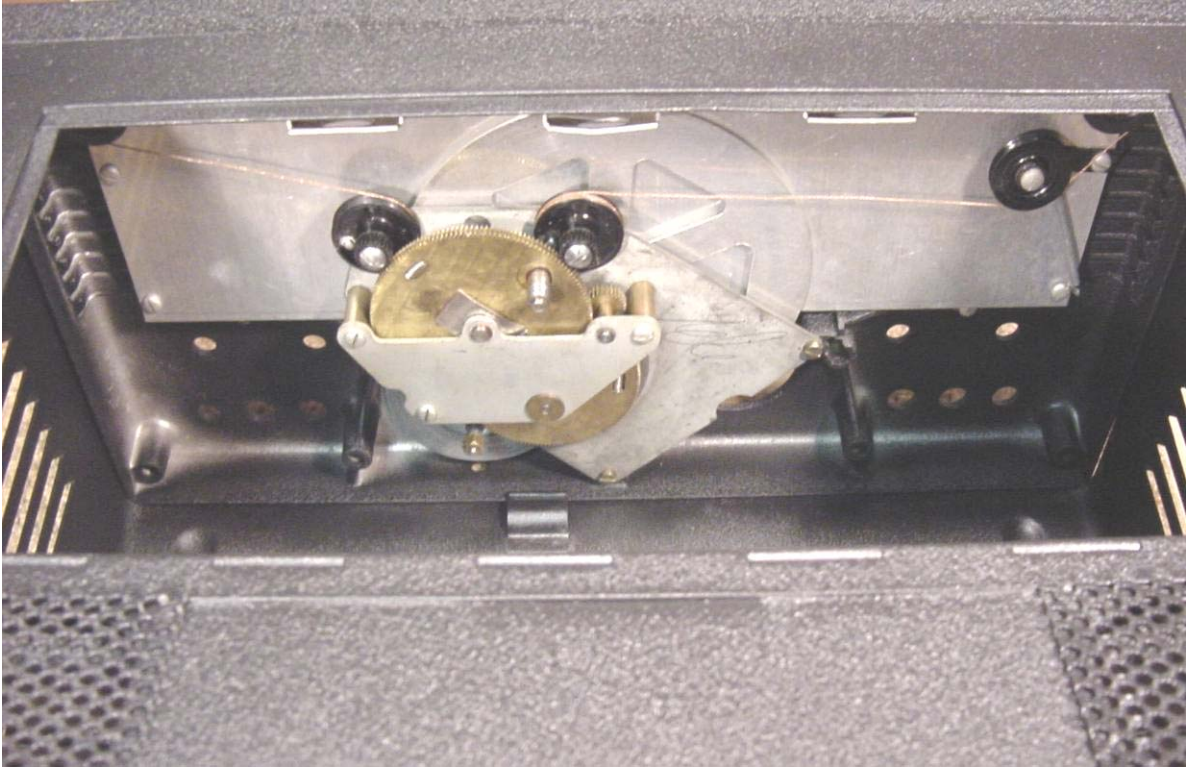

Above: 'peek-a-boo' view of the dial mechanism fitted into my recently powder-coated black crackle S.750 case (also shown on the photo on previous page). Below: close-up of the pinch wheel and friction plate. Note the brass insert in the flywheel.



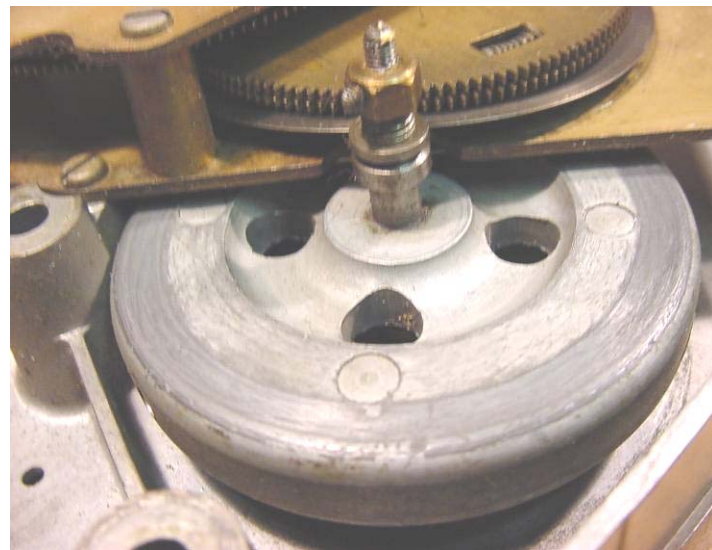
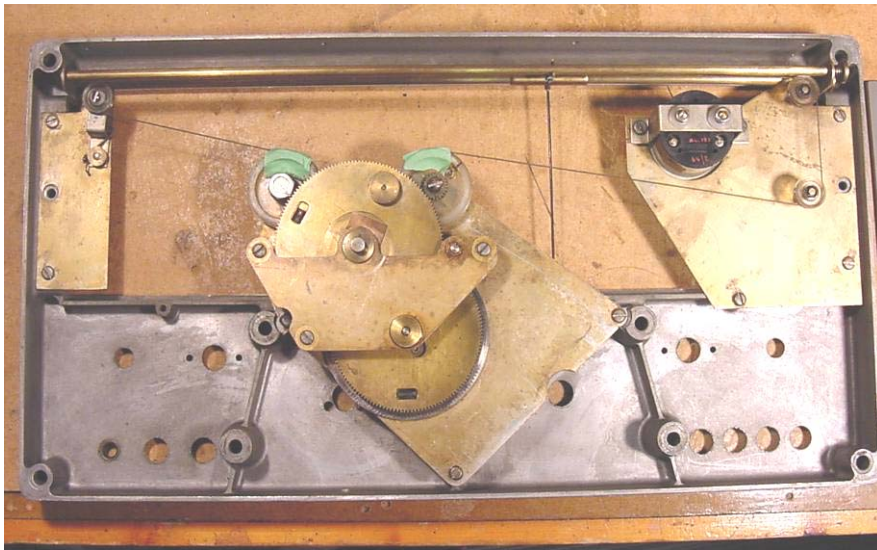
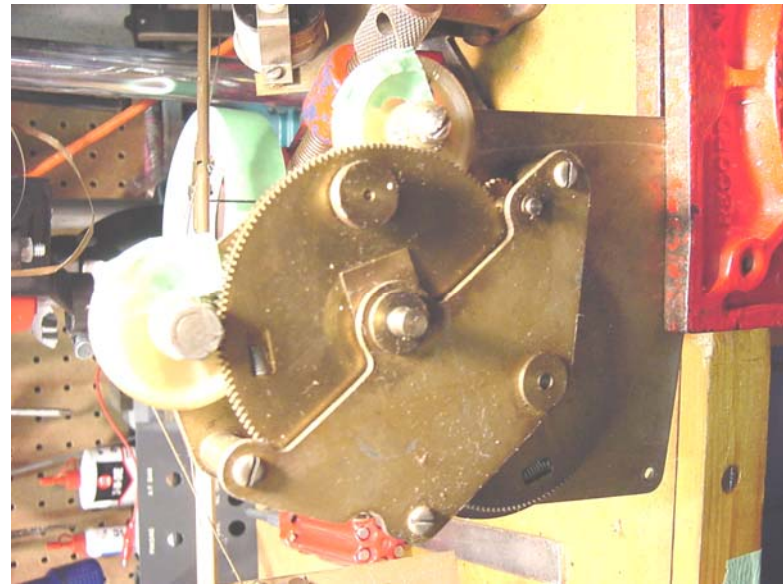
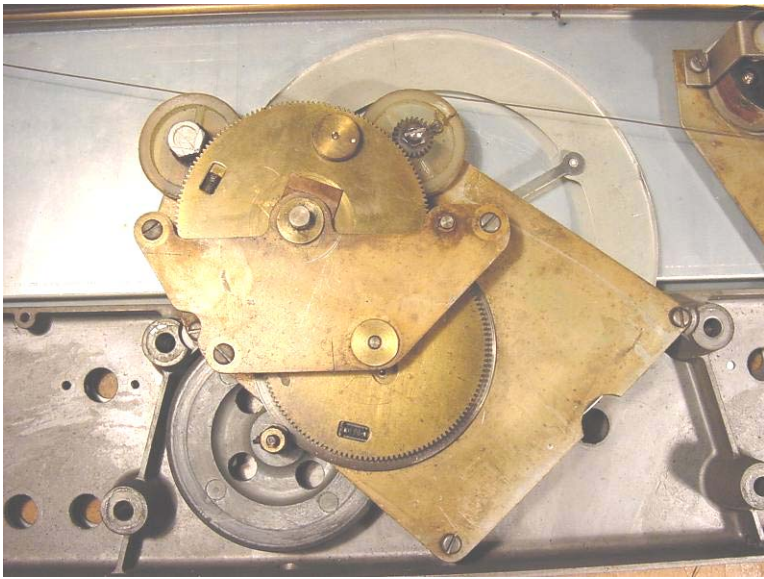

Above: Photos of the drive train from an S.940 – look familiar? Some part details are different, eg. the size of the spool pulleys and shoulder bolts (one missing here and a bolt substituted), the flywheel has lost its brass insert (and gained an extra grub screw) and the long ratio arm boss has warped into a stubby brass knob... but that's what happens when you get older (so I am told).

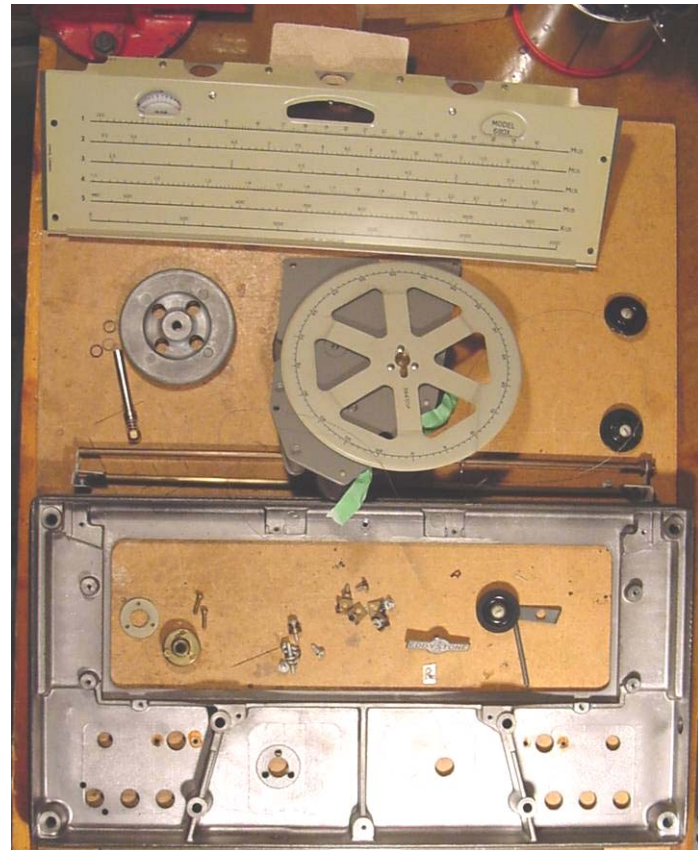
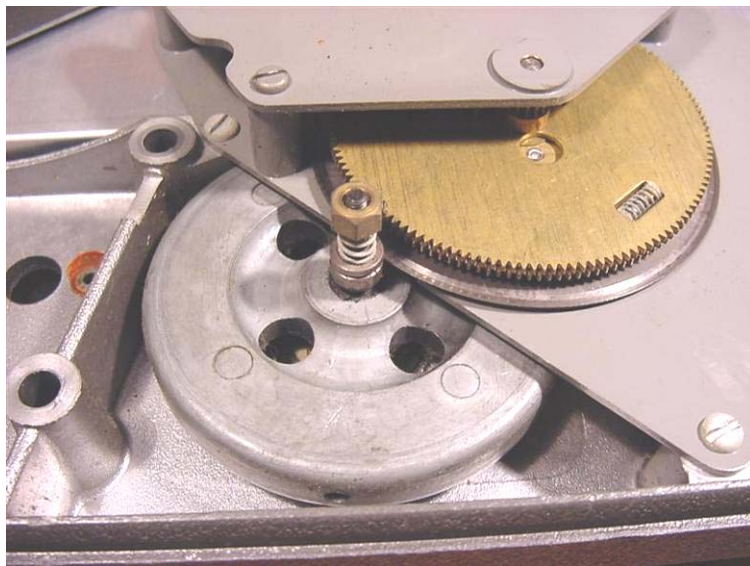
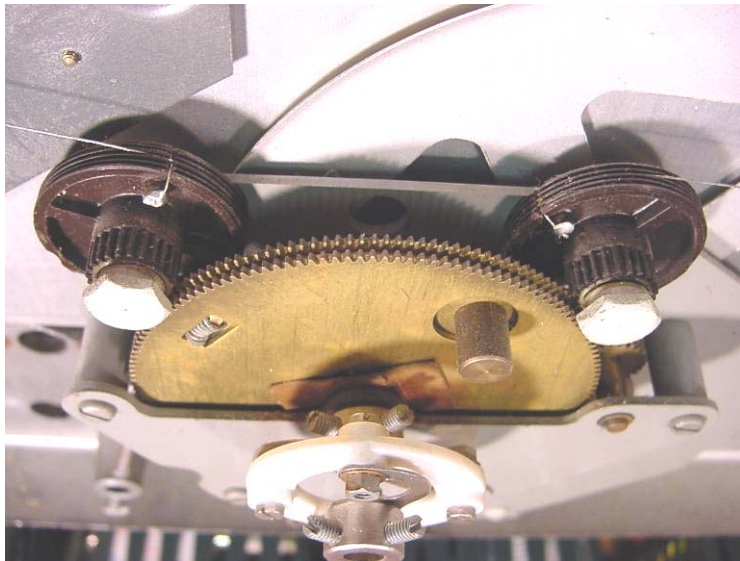

Above: Photos of the drive train from an S.680X – again, almost identical to the S.750 (but with a smart paint finish on the gearbox sides).

The Eddystone Dial Drive Mechanism and Gearbox

Gerry O'Hara

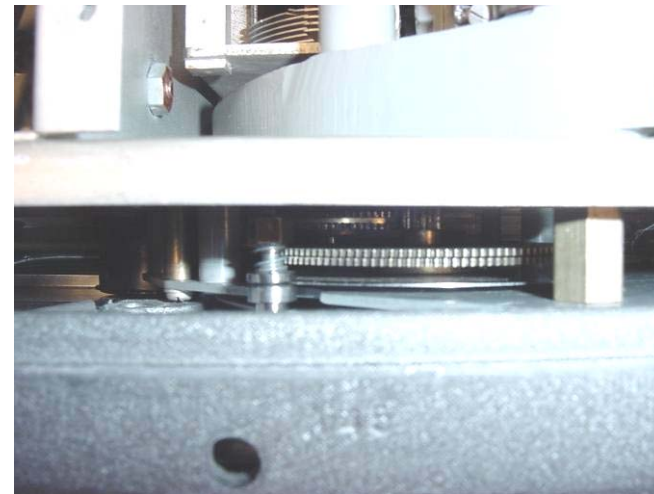
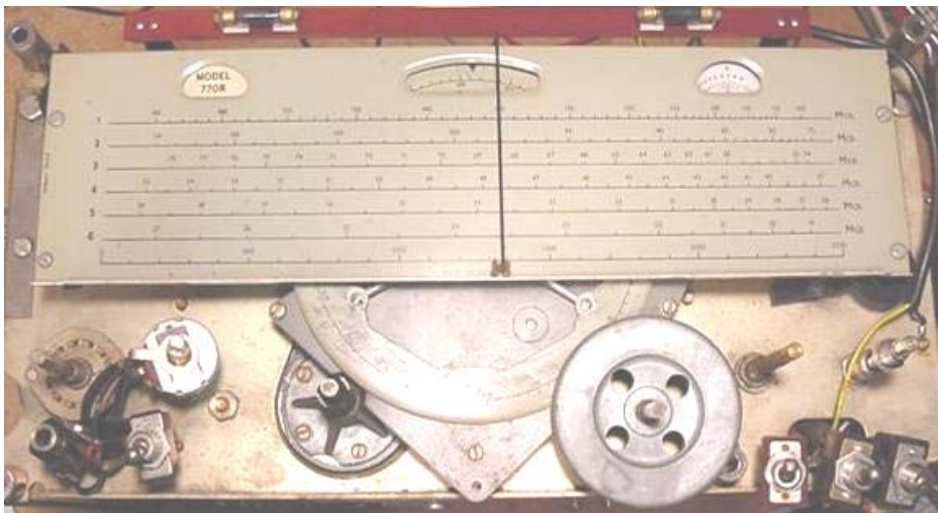
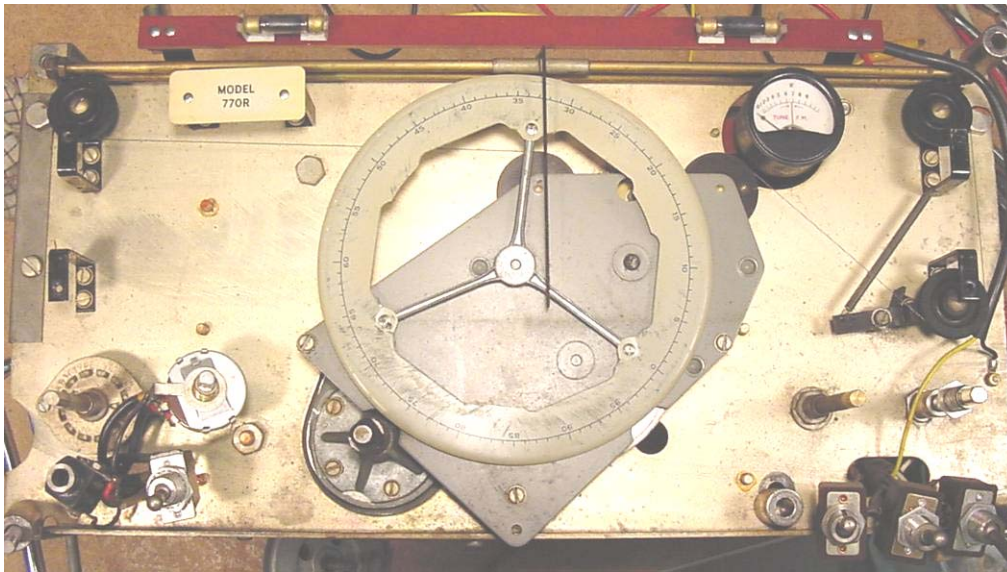

Above: Photos of the drive train from an S.770/R – again, very similar but here mounted on a sub-chassis plate behind the front panel casting.



Bench-mates... 15 years apart, same drive, just a bit different...

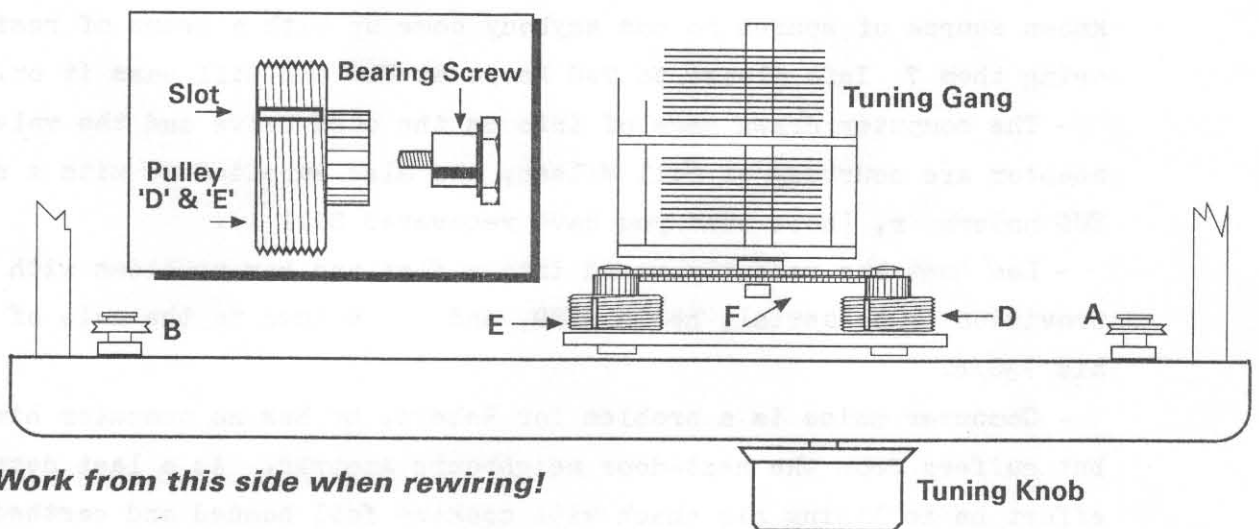
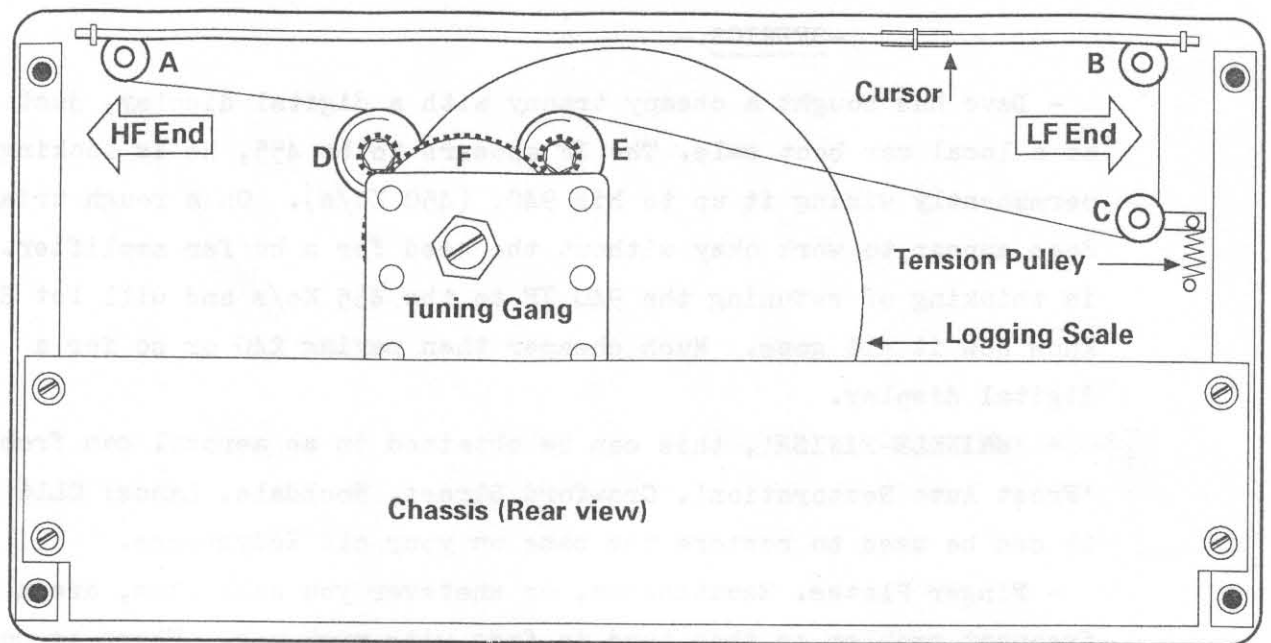

Work from this side when rewiring!

- 1 If the drive wire is still in situ, then sketch it and memorise its layout.
- 2 Remove all bits of old drive wire, temporarily remove the two pulleys 'D' & 'E'.
- 3 Slacken the tie-off screws on these pulleys, attach new drive wire to them with the wire coming out of the feed slot from the tie-off screw.
- 4 Rotate the tuning control fully clockways to end stop.
- 5 Refit right hand pulley 'D' with the slot at 'one o' clock, ensure the bearing screw is fully tightened. Feed wire into groove nearest to front of pulley (nearest to scale), so that it runs away from the pulley left to right, see sketch.
- 6 Feed wire up and over pulley 'A' and across to pulley 'B' and across pulley 'C' (the tension pulley). **Keep hand tension on the wire from now onwards!**
- 7 Rotate the tuning control till the other end stop is reached, keeping tension on the wire and checking that it feeds into the grooves on pulley 'D', You should end up with three full turns now on 'D'.
- 8 Feed the wire into the rearmost groove of pulley 'E' the furthest from you. Position pulley 'E' as close as is possible to its bearing point without actually engaging the drive cog teeth, tighten the tie-off screw to clamp the wire and rotate pulley 'E' slightly to add tension to wire so that tension pulley 'C' is now about 1/4 inch from its untensioned position, maintain tension and engage pulley teeth into drive cog teeth, screw in the bearing screw slightly.
- 9 Rotate the tuning control to the other end stop, checking that that the wire runs freely without kinks. Leave set fully clockways.
- 10 Set cursor to 2500 on logging scale, solder cursor to drive wire and check the free travel of the cursor from end to end of its travel. Check scale calibration using say, WWV or MSF if no signal generator is available. Adjust slightly by unsoldering if need be. See sketches.

Eddystone Radio 770U

THIS PORTION CUT-OUT TO SHOW DRIVE CABLE PASSED UNDER POINTER CARRIER.

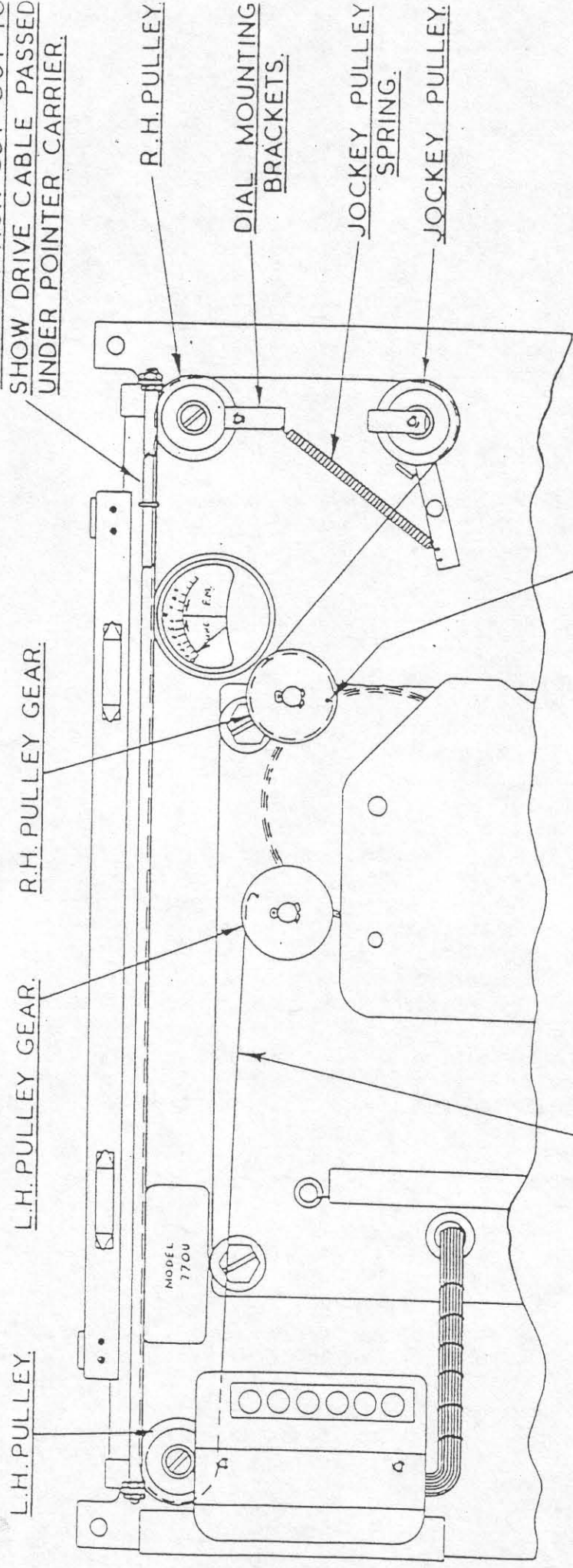

ANCHOR PIN TO BE IN POSITION SHOWN.

DRIVE CABLE.

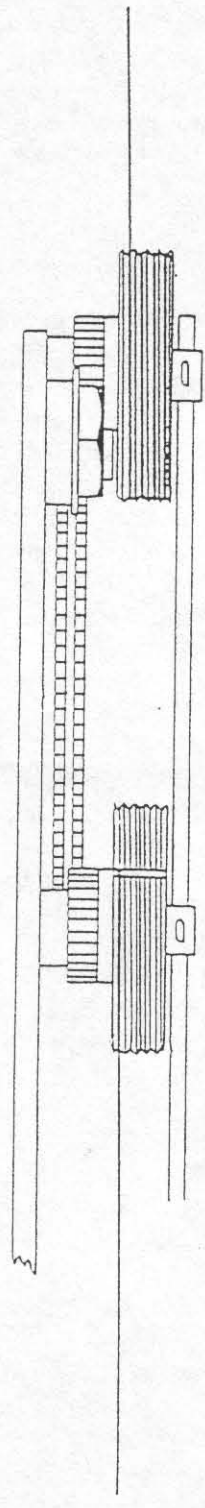

PLAN VIEW SHOWING CABLE FITTING ON PULLEY GEARS.

Drive Cable Fitting